

RTS

Round Tapered Steel Pole No Arm — 4-Bolt Base

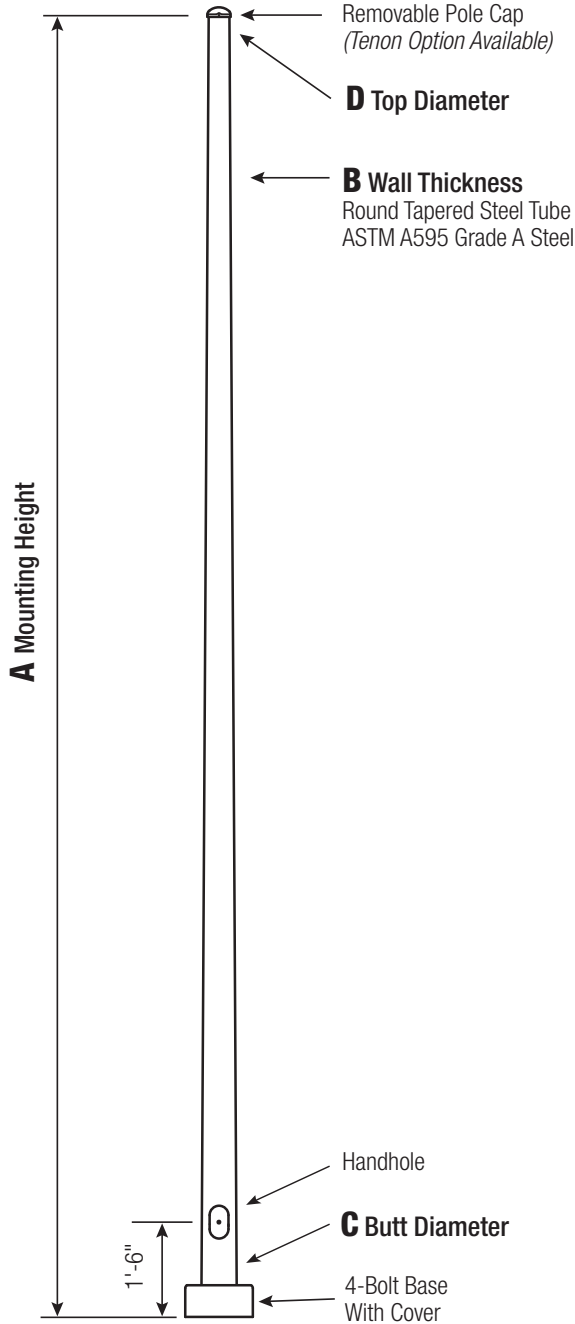

Powder Coated, Galvanized or Powder Coated over Galvanized Finish Per Customer Specification.

Pole

Pole shaft shall be weldable-grade, hot-rolled, commercial quality carbon steel tubing conforming to ASTM A595 Grade A. Options include 11 gauge and 7 gauge. All welds shall conform to AWS D1.1 using ER70S-6 electrodes.

Base Style

4-Bolt Steel Base Plate of fabricated hot rolled carbon steel conforming to ASTM A36 or equivalent (36 ksi minimum yield) with 2-piece Base Cover and attaching hardware. Base Cover will be fabricated from metal materials.

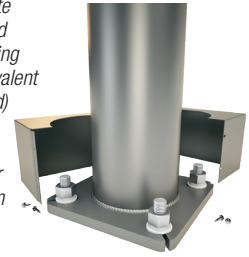

Anchorage

Anchorage Kit will include four (4) L-shaped Steel Anchor Bolts conforming to AASHTO M314-90 Grade 55. Ten inches (10") of threaded end will be galvanized per ASTM A153. Kits will contain eight (8) Hex Nuts, four (4) Lock Washers, and eight (8) Flat Washers (all components Galvanized Steel). A paper bolt circle template will be provided.

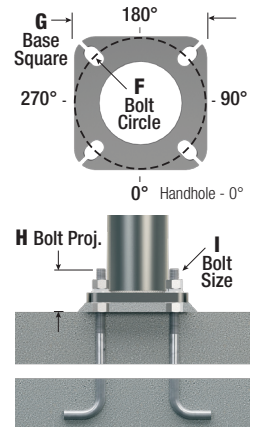

Handhole

Up To 5.9" Butt Diameters -
Reinforced, 3" x 5" Handhole with cover, stainless steel screw and backbar. A grounding provision incorporating a tapped 1/2"-13NC hole will be provided.



6"+ Butt Diameters -
Reinforced, 4" x 6-1/2" Handhole with cover, stainless steel screw and backbar. A grounding provision incorporating a tapped 1/2"-13NC hole will be provided.



Base Cover

Square metal powder coated Base Covers are standard on all RTS poles.

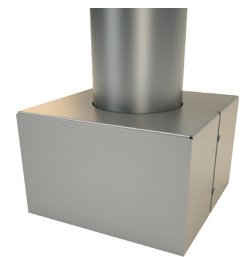

Vibration Damper

If determined necessary, or if specified by the customer, a first and/or second mode vibration damper will be provided.

4.5	7.5-8.5	8	3.75	.75 x 17 x 3
5.2	8 - 9	8.5	3.75	.75 x 17 x 3
6.1 - 6.6	9.5 - 10.5	10	3.75	.75 x 30 x 3
6.8	10 - 11	10	3.75	.75 x 30 x 3
7.0* - 7.5	10.5 - 11.5	10.5	4.875	1 x 36 x 4
8.0	11 - 12	11	4.875	1 x 36 x 4
8.5	11.5-12.5	12	4.875	1 x 36 x 4
9.0 (11 Gauge)	12 - 13	12.375	4.875	1 x 36 x 4
9.0 (7 Gauge)	13 - 14	12.75	5.875	1.25 x 48 x 6
10	13.5 - 14.5	13	4.875	1 x 48 x 4
11	15 - 16	14	5.875	1.25 x 48 x 6
12	16 - 17	15.5	6.75	1.5 x 54 x 6

*Nominal

Dimensions in Inches



Solar Lighting International®, Inc.

Phone +1 803-233-3461 | www.solarlightingintl.com

The Name Solar Lighting International® is a Registered Trademark.

WARNING: Do not install light pole without luminaire.

A MTG. HGT.	B WALL GAUGE	C BUTT DIA.	D TOP DIA.	TOTAL LUM. WEIGHT	MAXIMUM EPA						CATALOG NUMBER
					90	100	110	120	130	140	
10	11	4.5	3.1	370	31.5	25.2	23.5	19.5	16.4	14.0	RTS10B45-4-**
14	11	5.2	3.1	365	30.4	24.2	22.5	18.5	15.5	13.2	RTS14B52-4-**
20	11	6.1	3.3	340	25.9	20.4	18.8	15.4	12.8	10.8	RTS20B61-4-**
20	11	6.6	3.7	385	25.5	20.0	18.5	15.2	12.6	10.7	RTS20B66-4-**
25	11	6.1	2.6	280	19.0	14.7	13.5	10.8	8.8	7.2	RTS25B61-4-**
25	11	6.8	3.3	325	19.4	15.0	13.8	11.1	9.1	7.5	RTS25B68-4-**
30	11	6.8	2.6	275	14.6	11.1	10.1	7.9	6.2	5.0	RTS30B68-4-**
30	11	7.5	3.3	315	23.3	18.0	16.6	13.4	11.0	9.1	RTS30B75-4-**
30	11	8	3.8	345	27.4	21.4	19.7	16.1	13.4	11.3	RTS30B80-4-**
30	11	8.5	4.3	375	31.3	24.7	22.9	18.8	15.8	13.4	RTS30B85-4-**
30	11	9	4.8	405	35.2	27.9	25.9	21.5	18.1	15.4	RTS30B90-4-**
30	7	9	4.8	585	57.0	45.6	42.5	35.4	29.9	25.6	RTS30D90-4-**
35	11	7.5	2.6	265	17.0	13.1	11.9	9.4	7.5	6.0	RTS35B75-4-**
35	11	8	3.1	295	20.6	15.8	14.5	11.5	9.3	7.6	RTS35B80-4-**
35	11	8.5	3.6	320	23.9	18.4	17.0	13.7	11.2	9.3	RTS35B85-4-**
35	11	9	4.1	345	26.9	21.0	19.4	15.8	13.1	11.1	RTS35B90-4-**
35	7	9	4.1	490	44.9	35.5	33.0	27.2	22.9	19.4	RTS35D90-4-**
39	11	8	2.5	260	15.8	12.1	11.1	8.7	6.8	5.4	RTS39B80-4-**
39	11	9	3.5	305	21.9	16.8	15.4	12.3	10.0	8.2	RTS39B90-4-**
39	7	9	3.5	425	36.6	28.8	26.7	21.9	18.2	15.4	RTS39D90-4-**
39	11	10	4.5	350	25.4	19.8	18.2	14.9	12.4	10.4	RTS39B10-4-**
39	7	11	5.5	600	53.7	43.0	40.0	33.2	27.8	23.6	RTS39D11-4-**

Catalog Number System

The catalog number for these poles utilizes the following identification system.

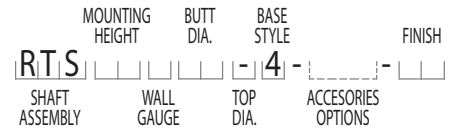

Catalog Number Example -

RTS 30 B 80 - 4 - BM

Round Tapered Steel, 30' Mounting Height, 11 Gauge, 8" Butt Diameter, Tapered, 4-Bolt Base, Dark Bronze Powder Coat Finish.

2-Piece Shaft Design

A MTG. HGT.	B WALL GAUGE	C BUTT DIA.	D TOP DIA.	TOTAL LUM. WEIGHT	MAXIMUM EPA						CATALOG NUMBER
					90	100	110	120	130	140	
45	11	10	3.9	285	19.2	14.6	13.4	10.5	8.5	7.0	RTS45B10-4-**
45	7	11	4.9	510	41.1	32.5	30.3	24.9	20.8	17.5	RTS45D11-4-**
45	7	12	5.9	600	57.9	47.3	44.4	37.1	31.7	26.7	RTS45D12-4-**
50	11	10	3.2	250	15.7	11.5	10.3	7.9	6.0	4.7	RTS50B10-4-**
50	7	11	4.2	495	34.4	26.9	24.7	20.9	16.7	13.9	RTS50D11-4-**
50	7	12	5.2	525	41.2	33.0	30.9	25.6	21.9	18.7	RTS50D12-4-**

EPA Notes:

Effective Projected Area (EPA) in square feet. EPA's calculated using wind velocity (mph) indicated in accordance with 2009 AASHTO LTS-5 using a 25-year design life. Maximum EPA is based on the luminaire weight shown. Increased luminaire weight may reduce the maximum EPA. If weight is exceeded, or if other design life or code is required, please consult the factory.

Mounting Options

Side Drill Mount

Includes removable pole cap.
NOTE: A luminaire drilling template must be supplied at time of order.



Tenon Mount

For Tenon Mount applications specify both Tenon diameter and length.



Drill Mount Options

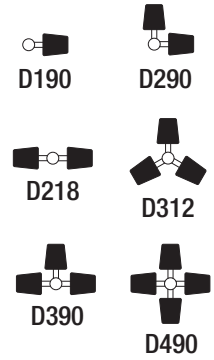

Electrical Box



Pole Orientation

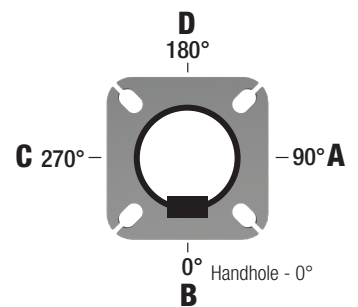

RTS- SQUARE STRAIGHT STEEL POLE	HEIGHT	GAUGE	BUTT DIA.	TOP DIA.	BASE STYLE	MOUNTING OPTIONS	ELECTRICAL BOX*	ACCESSORIES/OPTIONS*	FINISH
	10 = 10' 14 = 14' 20 = 20' 25 = 25' 30 = 30' 35 = 35' 39 = 39' 45 = 45' 50 = 50'	B = 11 Gauge D = 7 Gauge	45 = 4.5" 52 = 5.2" 61 = 6.1" 66 = 6.6" 68 = 6.8" 75 = 7.5" 80 = 8" 85 = 8.5" 90 = 9" 10 = 10" 11 = 11" 12 = 12"	- For Top Diameter Dimension See Column "D" in Product Information Table	4 = 4-Bolt Base	DRILL MOUNT D000 - No Drilling D190 - Std. "A" D290 - Std. "A" & "D" D218 - Std. "A" & "C" D390 - Std. "A", "D", & "C" D490 - Std. "A", "B", "C", & "D" DCUS - Custom* TENON T204 - 2-3/8" O.D. x 4" T304 - 2-7/8" O.D. x 4" T356 - 3-1/2" O.D. x 6" T406 - 4" O.D. x 6" TCUS - Custom Tenon** * Specify Number and Orientation ** Specify O.D. and Height	FA - 30" Up, "D" FB - 30" Up, "B" FC - 30" Up, "A" FD - 30" Up, "C" FE - 36" Up, "D" FF - 36" Up, "B" FG - 36" Up, "A" FH - 36" Up, "C" FI - 24" Up, "D" FK - 24" Up, "A" FL - 24" Up, "C" FZ - Custom** * GFI Receptacle Options Available (Specify in Accessories) ** Specify Height and Orientation	C12 - Threaded 1/2" Coupling** C34 - Threaded 3/4" Coupling** C10 - Threaded 1" Coupling** EHH - Extra Handhole** GF1 - Duplex GFI Receptacle (WR) with Cover GF2 - Duplex GFI (WR) with In-Use Cover LAB - Less Anchor Bolts LPC - Less Pole Cap PAB - Pre-shipped Anchor Bolts VD2 - Vib. Damper - 2nd Mode * Add all that apply (Example: CPL-LAB-VD1) ** Specify Location	POWDER COAT COLORS BA - Black Powder Coat BH - White Powder Coat BM - Dark Bronze Powder Coat BV - Dark Green Powder Coat GC - Gray Powder Coat XX - Special Colors* GALVANIZED 1Q - Galvanized Only 1C - Black PC Over Galv. 1D - White PC Over Galv. 1B - D. Bronze PC Over Galv. 1Y - D. Green PC Over Galv. 1J - Gray PC Over Galv. XX - Special PC Over Galv.* * Provide RAL # or Sample Color Chip